



Status

<input type="checkbox"/> Anfrage	<input type="checkbox"/> Bestellung
<input type="checkbox"/> Demoanforderung	

Datum	
-------	--

Daten des Händlers

Händler	
Adresse	
PLZ / Ort	
Kontaktperson	
E-mail	
Tel	
Fax	

Lieferadresse

Name	
Adresse	
PLZ / Ort	
Kontaktperson	
Kom.	



Daten des Benutzers

Vor- und Nachname		Wichtig Bitte aus- füllen!
Alter		
Gewicht		
1) Gesamtgröße stehend - cm		
2) Hüftbreite sitzend - cm		
3) Oberschenkelänge - cm		
4) Unterschenkelänge (U) - cm		
5) Ellenbogenhöhe (V) - cm		

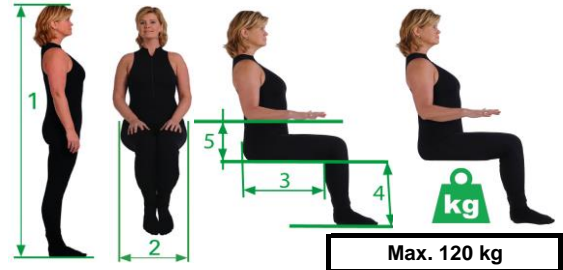

Gewünschte Einstellung

Sitzhöhe vorne (F) - cm		Standard = 53
Sitzhöhe hinten (G) - cm		Standard = 49
Radbilanz / Schwerpunkt (W) - cm		Standard = 8

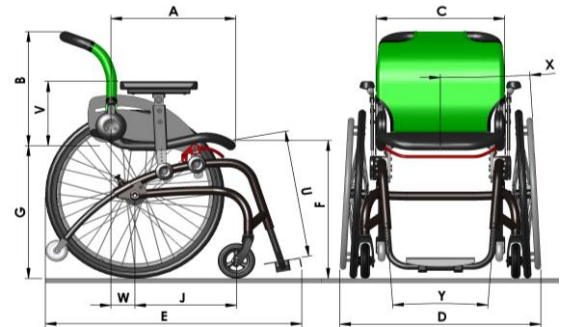

Bemerkungen Bestellblatt

Festverschweißst ==> Auf Anfrage

Grundpreis	€	2.395
-------------------	----------	--------------

Alle Preise exkl. MwSt.

Sonderbau :



Auslagen Optionen	€
Auslagen Sonderbau	€
Gesamt Verkaufspreis	€
Verpackungs- und Transportkostenanteil	€ 45,-





Unsere allgemeinen Geschäftsbedingungen sind im Internet einsehbar : www.O4.eu. Technische Änderungen und Druckfehler vorbehalten

O4 Wheelchairs GmbH T: +49 2821 711 4943 Siemensstraße 31, 47533 Kleve, Deutschland F: +49 2821 711 4946 E: info@O4.eu I: www.O4.eu

Sitzbreite (C)

<input type="checkbox"/> 34cm	<input type="checkbox"/> 36,5cm	<input type="checkbox"/> 39cm	<input type="checkbox"/> 41,5cm	<input type="checkbox"/> 44cm	<input type="checkbox"/> 46,5cm	<input type="checkbox"/> 49cm	<input type="checkbox"/> 51,5cm
Standard	Standard	Standard	Standard	Standard	Standard	Standard	Standard
Art : 800-40134	Art : 800-40136	Art : 800-40139	Art : 800-40141	Art : 800-40144	Art : 800-40146	Art : 800-40149	Art : 800-40151
<input type="checkbox"/> 29cm	<input type="checkbox"/> 31,5cm				<input type="checkbox"/> 54cm	<input type="checkbox"/> 56,5cm	<input type="checkbox"/> 59cm
Standard	Standard				Auf Anfrage	Auf Anfrage	Auf Anfrage
Art : 800-40129	Art : 800-40131				Art : 800-40154	Art : 800-40156	Art : 800-40159

Rahmenform (Y)

<input type="checkbox"/>	<input type="checkbox"/>	<input type="checkbox"/>	<input type="checkbox"/>
			
U-Form	V8	V16	Abduktion
Standard	€ 172	€ 172	€ 372
Fußraum = Sitzbreite - 10cm	lieferbar ab Sitzbreite 39cm Fußraum = Sitzbreite - 15cm	lieferbar ab Sitzbreite 44cm Fußraum = Sitzbreite - 20cm	Fußraum = Sitzbreite - 5cm
Art : 800-40210	Art : 800-40220	Art : 800-40230	Art : 800-40200

Rahmenlänge (J)

<input type="checkbox"/> 34cm	<input type="checkbox"/> 40cm	<input type="checkbox"/> 45cm
empfohlene Sitztiefen 37,5 - 42,5cm	empfohlene Sitztiefen 42,5 - 50cm	empfohlene Sitztiefen 45 - 50cm
Art : 800-40034	Art : 800-40040	Art : 800-40045

Rahmenfarbe

<input type="checkbox"/> Anthrazit	<input type="checkbox"/> Weiss RAL 9016	<input type="checkbox"/> Blau RAL 5002	<input type="checkbox"/> Schwarz RAL 9005	<input type="checkbox"/> Rot RAL 3003	<input type="checkbox"/> Speziell - UNI	<input type="checkbox"/> Speziell - Metallic
Standard	Standard	Standard	Standard	Standard	€ 90	Auf Anfrage
					Immer gewünschte Ral Farbe angeben nach www.RAL-kleuren.com	
Art : 800-40310	Art : 800-40330	Art : 800-40335	Art : 800-40340	Art : 800-40345	Art : 800-40350	Art : 800-40300

Radsturz (X)



<input type="checkbox"/> 0°	<input type="checkbox"/> 3°	<input type="checkbox"/> 6°	<input type="checkbox"/> 9°
Standard	Standard	€ 100	€ 172
Art : 800-40400	Art : 800-40403	Art : 800-40406	Art : 800-40409

Fußraste (U)

Unterschenkellänge Einstellbereich (bei niedrigster vorderer Sitzhöhe von 47cm mit 24-Zoll Antriebsrad)			
<input type="checkbox"/>	<input type="checkbox"/>	<input type="checkbox"/>	<input type="checkbox"/>
			
Gebogen	rechtwinklig	hochklappbar 1-teilig	hochklappbar 2-teilig
Unterschenkellänge 39 - 44cm	Unterschenkellänge 33 - 38cm	Unterschenkellänge 33 - 44cm	Unterschenkellänge 33 - 44cm
		Max. Benutzergewicht 80kg Einstelßfußraum : min 24cm U-Form : Ab Sitzbreite 39cm V8 : Ab Sitzbreite 44cm	Rahmenverstärkung stark empfohlen
Standard	Standard	€ 218	€ 309
Art : 200 - 38100	Art : 200 - 38200	Art : 200 - 38300	Art : 200-38500



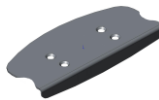



Fußplatten

<input type="checkbox"/>	<input type="checkbox"/>	<input type="checkbox"/>	<input type="checkbox"/> Maßarbeit	<input type="checkbox"/> Maßarbeit
			Aluminium	Kunststoff
Standard (23 x 12cm) Aluminium	Breit (29 x 12cm) Aluminium	Tief (23 x 19cm) Aluminium	in Anfertigung nach Skizze	
Standard	€ 68	€ 68	Auf Anfrage	
Art : 800 - 38009	Art : 800 - 38010	Art : 800 - 38040	Art : 800 - 3801 x	Art : 800 - 3802 x

Sitztiefe (A)

<input type="checkbox"/> 35cm	<input type="checkbox"/> 37,5cm	<input type="checkbox"/> 40cm	<input type="checkbox"/> 42,5cm	<input type="checkbox"/> 45cm	<input type="checkbox"/> 47,5cm	<input type="checkbox"/> 50cm
Nur mit RCA 1.5					Nicht mit RCA1.5	
Art : 800-40535	Art : 800-40537	Art : 800-40540	Art : 800-40542	Art : 800-40545	Art : 800-40547	Art : 800-40550



Sitz

<input type="checkbox"/>	<input type="checkbox"/>	<input type="checkbox"/>	<input type="checkbox"/>
			
Sitz für Fremdkissen mit Bespannung 'Cordura'	Sitz für Fremdkissen aus Aluminium Auflage nur in Kombination mit RCA 1.5	Sitz für Fremdkissen Seat E-Lastica nur in Kombination mit RCA 1.5	Sitz Kontur ergonomisch, gepolstert
Standard	€ 527	€ 290	€ 482
Art : 100-140 x x	Art : 100-133 x x	Art : 100-142 x x	Art : 100-122 x x

Sitzkissen

<input type="checkbox"/>	<input type="checkbox"/>	<input type="checkbox"/>
		Maßanfertigung
Sitzkissen Hart	Sitzkissen Weich	in Anfertigung nach Skizze
6 cm Verbundschaum	3 cm Latex oben + 2 cm Verbundschaum unten	
€ 94	€ 159	Auf Anfrage
Art : 100-412 x x	Art : 100-411 x x	Art : 100-413 x x





Rückendrehgelenk

<input type="checkbox"/>	<input type="checkbox"/>	<input type="checkbox"/>
		
Basic	RCA 1.0	RCA 1.5
Rücken abklappbar und Rückenwinkel mechanisch voreinstellbar	Rückendrehgelenk zentriert	Rückendrehgelenk 2,5 cm rückversetzt
(Verstellbereich 85 - 115°)	vom Nutzer in 3° -Schritten manuell verstellbar (Verstellbereich 0 - 85 - 115°) RCA = Remote Continuous Adjustable	
Standard	€ 432	€ 497
Art : 100-38000	Art : 100-32000	Art : 100-36000

<input type="checkbox"/>

Verstärker RCA 1.0 (Spasmus)
Rückendrehgelenk zentriert
Preis auf Anfrage
Art : 100-32500



Rückenform

<input type="checkbox"/>	<input type="checkbox"/>	<input type="checkbox"/>	<input type="checkbox"/>
			
Gerade Form	Ergonomisch, anatomisch ab Rückenhöhe 40cm	Rückenlehne Frauen ergonomisch, anatomisch möglich ab Höhe 40 cm	Deltarückenform, nur in Sitzbreite 39cm, 41,5cm und 44cm
Standard	€ 393	€ 495	€ 495
Art : 100-225 x x	Art : 100-200 x x	Art : 100-220 x x	Art : 100 - 240 x x







Rückenhöhe (B)

<input type="checkbox"/>	<input type="checkbox"/>	<input type="checkbox"/>	<input type="checkbox"/>
			
Höhe 35cm	Höhe 40cm	Höhe 45cm	Höhe 50cm
Art : 800-42135	Art : 800-42140	Art : 800-42145	Art : 800-42150

Höhe Deltarückenlehne

<input type="checkbox"/>	<input type="checkbox"/>
	
Höhe 60cm	Höhe 70cm
Art : 800-42160D	Art : 800-42170D

Farbe Rückenpolsterung





<input type="checkbox"/>	<input type="checkbox"/>	<input type="checkbox"/>	<input type="checkbox"/>	<input type="checkbox"/>	<input type="checkbox"/>	<input type="checkbox"/>
						Wechselbezug
Orange	Rot	Schwarz	Blau	Dunkelblau	Silbergrau	Farbe :
Standard	Standard	Standard	Standard	Standard	Standard	€ 91
Art : 100-400 x x	Art : 100-401 x x	Art : 100-402 x x	Art : 100-403 x x	Art : 100-405 x x	Art : 100-406 x x	Art : 100-400 x x

Radgrößen

Mögliche Sitzhöhe siehe Maßblatt

<input type="checkbox"/> 22" x 1 - (25 - 489)	<input type="checkbox"/> 24" x 1 - (25 - 540)	<input type="checkbox"/> 25"	<input type="checkbox"/> 26" x 1 - (25 - 590)	<input type="checkbox"/> 28"
€ 76	Standard	€ 102	€ 102	€ 102
Marathon Plus Evolution Bereifung				
nur in Kombination mit 4" Vorderrädern				
Art: 800-41022	Art: 800-41024	Art: 800-41025	Art: 800-41026	Art: 800-41028

Antriebsräder (Satzet, mit Quick-Release)

Satz <input type="checkbox"/>	Satz <input type="checkbox"/>	Satz <input type="checkbox"/>	Satz <input type="checkbox"/>
			
Standard	Trommelbremsen (Satz) Inkl. Rahmen-Änderung. Standard mit schwarzem Aluminium Greifreifen. Nur in 24" lieferbar. Schliebefügel stark empfohlen.	Edco Nabenblockierung	Antriebsräder verstärkt
	€ 1.018	€ 190	€ 356,40
Art : 800-41024	Art : 991 - 42 x x x	Art : 991 - 2 x 101	Art : 991 - 2 X 202

Sportlich

<input type="checkbox"/>	<input type="checkbox"/>	<input type="checkbox"/>
Leichtgewicht Spinergy-Räder	Leichtgewicht Tensio-Räder	Tensio Heavy-Duty-Räder
Satz	Satz	Satz
Auf Anfrage	Auf Anfrage	Auf Anfrage
Art : 991 - 43 x x x	Art : 991 - 455 0 x	Art : 991 - 455 1 x

Einhandantrieb





Antrieb Links <input type="checkbox"/>		Antrieb Rechts <input type="checkbox"/>
Einhandantrieb (Hemi) - Antriebsräder inkl. geeignete Rahmen. Niedrigsten Sitzhöhe 2 cm höher (Vorne und Hinten). Nicht möglich mit 6°-9° Radsturz Nur mit 24" Radgrosse		
€ 1.363		
Art : 991 - 41 x x x		

Bereifung



<input type="checkbox"/>	<input type="checkbox"/>	<input type="checkbox"/>	<input type="checkbox"/>	<input type="checkbox"/>
				
Schwalbe Marathon Plus Evolution	PU-Bereifung	Schwalbe Right Run Rot	Schwalbe Right Run Blau	Schwalbe Right Run Grau
Standard	€ 85	€ 0	€ 0	€ 0
Art : 991-67 x 01	Art : 991-67 x 11	Art : 991-67 X 21	Art : 991-67 X 22	Art : 991-67 X 23

<input type="checkbox"/>
Alber-Antriebe
Zurüstung Alber-Antrieb ist technisch möglich, Rahmenanpassung empfohlen € 104,-
Lieferung Antriebsystem durch Händler

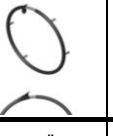
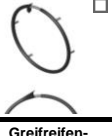





Greifreifen (Paar)

<input type="checkbox"/>	<input type="checkbox"/>	<input type="checkbox"/>	<input type="checkbox"/>	<input type="checkbox"/>	Links <input type="checkbox"/>	Rechts <input type="checkbox"/>	Greifreifenabstand	
							<input type="checkbox"/> eng	<input type="checkbox"/> weit
Aluminium	TETRA	PARA	ERGO	Edelstahl	Greifreifen-Überzug (1 Stück)	Greifreifen-Überzug (1 Stück)		
Standard	€ 430,00	€ 430,00	€ 468,00	€ 245,00	€ 88,00	€ 88,00	Standard	Ohne Aufpreis
	Grippverstärkend	Grippverstärkend	Grippverstärkend					
Art : 800-62x11	Art : 800-62x01	Art : 800-62x02	Art : 800-62x03	Art : 800-62x12	Art : 991-61x01	Art : 991-61x01	-	-

Radzubehör (Paar)

Set <input type="checkbox"/>	Set <input type="checkbox"/>
	
Speichenschutz transparent	Speichenschutz mit O4-Aufdruck
€ 120	€ 100
Art : 991 - 60 x 01	Art : 991 - 60 x 02

Bremsen

Links <input type="checkbox"/>		Rechts <input type="checkbox"/>		Links <input type="checkbox"/>		Rechts <input type="checkbox"/>		Links <input type="checkbox"/>		Rechts <input type="checkbox"/>	
											
Ziehbremse (ziehen zum Bremsen)		Druckbremse (drücken zum Bremsen)		S-Bremse Nur möglich mit Sitztiefe 40-42,5-45cm		S-Bremse Nur möglich mit Sitztiefe 40-42,5-45cm		Aktivbremse		Aktivbremse	
Standard		Standard		€ 58		€ 58		€ 139		€ 139	
Art : 800-47103	Art : 800-47203	Art : 800-47104	Art : 800-47204	Art : 800-47102	Art : 800-47202	Art : 800-47106	Art : 800-47206	Art : 800-47106	Art : 800-47206	Art : 800-47106	Art : 800-47206





Links <input type="checkbox"/>		Rechts <input type="checkbox"/>	
			
Lange Druckbremse, abklappbar (drücken zum Bremsen)			
€ 58		€ 58	
Art : 800 - 07105	Art : 800 - 07205	Art : 800 - 07105	Art : 800 - 07205





Links <input type="checkbox"/>		Rechts <input type="checkbox"/>	
			
Einhandbremse (drücken zum Bremsen)			
€ 290			
Art : 800-47110			

Lenkräder (Satz)







Mögliche Sitzhöhen siehe technisches Maßblatt

<input type="checkbox"/>		<input type="checkbox"/>	
			
Soft 6'' Kunststoff (nur in Kombination mit 28'' Hinterrädern)		Super Soft 6'' Kunststoff mit breiter Auflagefläche (nur in Kombination mit 28'' Hinterrädern)	
€ 22		€ 296	
Art : 800 - 06001	Art : 800 - 06001	Art : 800 - 06004	Art : 800 - 06004





<input type="checkbox"/>	<input type="checkbox"/>	<input type="checkbox"/>	<input type="checkbox"/>
			
Soft 5'' Kunststoff	Hart 5'' Kunststoff	Hart 5'' Aluminium	Super Soft 5'' Kunststoff mit breiter Auflagefläche
Standard	€ 25	€ 115	€ 260
Art : 800 - 05001	Art : 800 - 05002	Art : 800 - 05003	Art : 800 - 05004

<input type="checkbox"/>	<input type="checkbox"/>	<input type="checkbox"/>	<input type="checkbox"/>
			
Soft 4'' Kunststoff	Hart 4'' Kunststoff	Hart 4'' Aluminium	Super Soft 4'' Kunststoff mit breiter Auflagefläche
€ 22	€ 25	€ 90	€ 260
Art : 800 - 04001	Art : 800 - 04002	Art : 800 - 04003	Art : 800 - 04004

Kippschutz







Links <input type="checkbox"/>		Rechts <input type="checkbox"/>		Links <input type="checkbox"/>		Rechts <input type="checkbox"/>		Links <input type="checkbox"/>		Rechts <input type="checkbox"/>	
											
Kippschutz - teleskopisch höhenverstellbar		Kippschutz - 360° drehbar (einseitig montierbar)		Kippschutz - wegschwenkbar (nicht mit 28'' Radgröße)		Antikippbügel - fest (nicht in Kombination mit Kippschutz-Paar)		Antikippbügel - fest (nicht in Kombination mit Kippschutz-Paar)		Stockhalter	
€ 128		€ 128		€ 184		€ 184		€ 82		€ 82	
Art : 800 - 44000	Art : 800 - 45000	Art : 800-44010	Art : 800-45010	Art : 800-44020	Art : 800-45020	Art : 800-43000	Art : 800-43500	Art : 800-43010	Art : 800-43510	Art : 800-43010	Art : 800-43510

Seitenteile





<input type="checkbox"/> Satz 	<input type="checkbox"/> Satz 	<input type="checkbox"/> Satz 	<input type="checkbox"/> Satz 	<input type="checkbox"/> Satz 
Seitenteil fest, Kunststoff, nach Unten abklappbar Nur in Kombination mit Sitz Cordura und Rückendrehgelenken 'Basic'	Seitenteil abnehmbar ohne Spritzschutz, nur in Kombination mit Armlehnen	Seitenteil fest, ohne Spritzschutz, Aluminium	Seitenteil fest mit Spritzschutz, Aluminium	Seitenteil fest mit Spritzschutz, Carbon
€ 0,-	€ 96	€ 96	€ 204	€ 322
Art : 100 - 96070	Art : 100 - 96030	Art : 100 - 96040	Art : 100 - 96050	Art : 100 - 96010





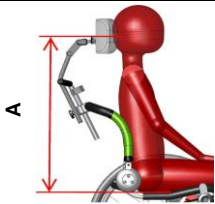

Armlehnen



Armauflagen (in Kombination mit winkeleinstellbaren Armlehnen)





<input type="checkbox"/> Set 	<input type="checkbox"/> Set 	<input type="checkbox"/> Links 	<input type="checkbox"/> Rechts 	<input type="checkbox"/> Links 	<input type="checkbox"/> Rechts 	Maßarbeit	
höhenverstellbare Armlehnen, abnehmbar, fester Winkel, Bei Montage für Seitenteil mit Spritzschutz (nur Carbon) Aufpreis für Arbeitswert	höhenverstellbare Armlehnev, abnehmbar, winkeleinstellbar Bei Montage für Seitenteil mit Spritzschutz (nur Carbon) Aufpreis für Arbeitswert	Hemiplegie-Armauflage (Stück)		Armauflage Lang (Stück) (standard Länge + 10cm)		Armauflage - in Anfertigung nach Skizze (Stück)	
€ 330	€ 420	€ 205	€ 205	€ 75	€ 75	Auf Anfrage	Auf Anfrage
Art : 100 - 96110	Art : 100 - 96170	Art : 100 - 96140	Art : 100 - 96240	Art : 100 - 96180	Art : 100 - 96280	Art : 100 - 96130	Art : 100 - 96230

Zubehör

<input type="checkbox"/> 	<input type="checkbox"/> 		<input type="checkbox"/> 1 Stück 	<input type="checkbox"/> 2 Stück
höhenverstellbarer Schiebebügel	Kopfstütze, Höhe einstellbar (Maß A angeben)		Einhängegriff für Rückenbügel Wird nicht montiert	
€ 225	€ 237		€ 98	€ 196
Art : 100 - 210 x x	Art : 100 - 230 x x	A (cm) =	Art : 100 - 47010	Art : 100 - 47020

<input type="checkbox"/> links 	<input type="checkbox"/> rechts 	<input type="checkbox"/> links 	<input type="checkbox"/> rechts 	<input type="checkbox"/> 1 Stück 	<input type="checkbox"/> 2 Stück	<input type="checkbox"/> 1 Stück 	<input type="checkbox"/> 2 Stück
Seitenpelotte klein 10x12cm ab RH 45cm Wird nicht montiert	Seitenpelotte groß 14x14cm ab RH 45cm Wird nicht montiert	Seitenpelotte groß 14x14cm ab RH 45cm Wird nicht montiert	Seitenpelotte groß 14x14cm ab RH 45cm Wird nicht montiert	Elastisch anpaßbarer Rückengurt mit Seat-E-Lastica Material, 50mm breit, einstellbar Wird nicht montiert		Elastisch anpaßbarer Rückengurt mit Seat-E-Lastica Material, 100 mm breit , einstellbar Wird nicht montiert	
€ 288		€ 308		€ 62	€ 124	€ 62	€ 124
Art : 800-01102	Art : 800-01202	Art : 800-01101	Art : 800-01201	Art : 100 - 46001	Art : 100 - 46002	Art : 100 - 46011	Art : 100 - 46012

<input type="checkbox"/> 	<input type="checkbox"/> 
Inkontinenz-Schutzhülle	Extra Sitzbezug
€ 103	€ 103
Art : 800 - 01001	Art : 100 - 111 x x

<input type="checkbox"/> 	<input type="checkbox"/> 	<input type="checkbox"/> 	<input type="checkbox"/> 
Wadenband	Therapietisch	Sicherheitsgurt	Utensilentasche
€ 34	Auf Anfrage	€ 92	€ 84
Art : 800 - 01001	Art : 800 - 01003	Art : 800-01002	Art : 800 - 01010

Activ- Passiv Modul

Sitzbreiten siehe Seite 2
Sitztiefen siehe Seite 2

<input type="checkbox"/>	im Sitz integriertem AP-Modul in Kombination mit RCA 1.0 oder RCA 1.5		
	Mögliche Sitzbreiten: 39 - 41,5 - 44 - 46,5		
	Manueller Bedienung		
	Bedienung:		
<input type="checkbox"/>	Links	rechts	<input type="checkbox"/>
	€ 1.380		
	Art : 800-40730		

*: A.P.-Module = Aktiv-Passiv-Modul
Nur mit Rahmenlänge 40cm

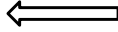

Dieses Rollstuhl-Modell wurde nach ISO 7176-19 mit einem Rückhaltesystem nach ISO 10542 crashgetestet und ist damit für den befestigten Transport in Fahrzeugen zugelassen. Rückhaltesysteme erhalten Sie bei der Firma AMF Bruns in Apen.

**Bitte senden Sie uns dieses Formular komplett ausgefüllt
an unsere Fax Nr : +49 2821 711 4946 oder per E-Mail an Info@o4.eu**

Unsere allgemeinen Geschäftsbedingungen sind im Internet einsehbar : www.O4.eu

Wheelchairs GmbH T: +49 2821 711 4943 Siemensstraße 31, 47533 Kleve, Deutschland F: +49 2821 711 4946 E: info@O4.eu I: www.O4.eu